

# **iKONVERT GATEWAY (USB)**

Installation and instruction Manual



## 1. Introduction

Congratulations on the purchase of your iKonvert (USB) Gateway. This product is designed to allow NMEA2000 data to be displayed on a computer and for the computer to send navigational data back on to the NMEA2000 network.

Although the USB interface is simple “plug and play”, wiring the Gateway to a NMEA2000 network requires a level of practical ability and electrical knowledge. If you are not comfortable with electrics/electronics and making wiring connections, we recommend you have the converter installed by a professional installer/dealer.

** Before operating the unit you should also familiarise yourself again with the user manual of the NMEA2000 equipment and Navigation Software that you will be using it with. Pay particular attention to the NMEA2000 network wiring, the Software’s Interfacing Menu options and any other settings that need to be configured for correct operation.**

## 2. Before you start

If you need to extend the USB cable of the iKonvert converter, please note that the maximum length of a standard USB cable is 5m, so avoid extending the iKonvert USB cable beyond this length.

To install and test the iKonvert (USB) converter you will need:

- Suitable tools and connectors to connect the iKonvert to the NMEA2000 network
- M3 or M4 screws or other fixings appropriate to the mounting location
- Suitable Windows/Mac/LINUX PC with a spare USB port
- The Digital Yacht Software and Drivers CD (supplied with the iKonvert)
- Suitable Navigation software running on the Windows/Mac/LINUX PC that can read the converted data

## 3. Installation

Before starting installation select a suitable location for the iKonvert. The unit is water resistant; however it should be installed below deck in a dry location. When locating the unit you should consider:

- Routing of NMEA2000 and USB cables to the unit
- Provision of sufficient space around the unit for comfortable cable routing.
- Maintaining the compass safe distance of 0.5m

### 3.1 Connecting to NMEA2000 Network

- The iKonvert, has an integral NMEA2000 cable terminated with a male connector that is designed to connect straight in to a standard NMEA2000 network via a spare “T-Piece”. If you are creating a new NMEA2000 network, then you may wish to consider [Digital Yacht’s NMEA2000 Starter Kit](#), that provides all of the cables, connectors and terminators required for a basic NMEA2000 network.
- iKonvert takes its power and data from the NMEA2000 network.
- If you are connecting iKonvert to a non-standard NMEA2000 network, then a suitable adaptor cable will need to be sourced from the relevant manufacturer;
  - SeaTalkNG (Raymarine P/No A06045)
  - Simnet (Simrad P/No 24006199)



### 3.2 Mounting

- The iKonvert Gateway has two slotted 4mm Diameter fixing holes. Use suitable fixings (not supplied) to fix the converter to a flat surface – using the dimensions and details shown in the drawing below. Note that the unit may be installed in any orientation.

#### Dimension drawing

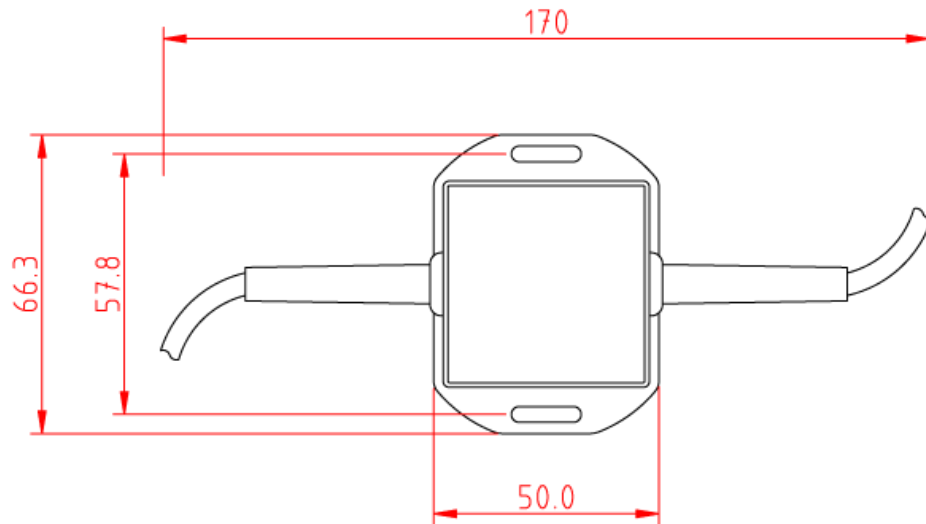

### 3.3 USB Connection

The iKonvert Gateway (USB) has an integral 1m USB cable allowing it to be easily plugged in to any computer with a spare USB type A socket. Before connecting the iKonvert Gateway to the PC, it is necessary to install the USB drivers. The exact procedure varies between the different types of Operating Systems that exist for PCs, but the following section details the procedure for the popular operating systems;

#### Windows XP

On the **Digital Yacht Software and Drivers CD**, there is a folder called “USB Drivers for AIS units” which contains the drivers required for the iKonvert Gateway. Double click on the “USB Driver Setup” program and make sure that a DOS Command window opens and a series of commands are executed – normally takes 10-15secs to complete.

Once the program has finished, insert the cable of the iKonvert Gateway in to a spare USB port and the Windows “Found New Hardware” wizard should briefly appear while the PC completes the installation.

You may need to enter the Windows Device Manager to find out what COM Port the Gateway has been allocated by Windows. In the Device Manager, the iKonvert Gateway should appear in the **Ports COM & LPT** section as a “USB Serial Port (COMx)” where x = the COM Port number allocated by Windows to the Gateway. This is the COM port number that you will need to enter in your Navigation Software to tell it where to get the NMEA2000 data from.

For more information on the Device Manager, visit our blog at [www.digitalyacht.net](http://www.digitalyacht.net) and search for Device Manager. You should then be able to see an article called “Managing the Device Manager” that explains this process.

#### Windows Vista/7/8/10

The easiest way to install the drivers on these operating systems, is to plug the iKonvert Gateway in to your PC when you have a good internet connection. Windows will see the new hardware and automatically search online for the latest drivers, download them and then install them. The whole process takes about 2-3 minutes and is completely automatic.

If you are on the boat and do not have an internet connection, then insert the **Digital Yacht Software and Drivers CD** in to your PC and browse to the folder called “USB Drivers for AIS units” which contains the drivers required for the iKonvert Gateway. Right click on the “USB Driver Setup” program and select the option “Run as administrator”.



The program should now open a DOS Command type window and execute a series of commands – normally takes 10-15secs to complete. Once the program has finished, insert the cable of the iKonvert Gateway in to a spare USB port on the PC and the Windows “Found New Hardware” wizard should briefly appear while the PC completes the installation.

You may need to enter the Windows Device Manager to find out what COM Port the Gateway has been allocated by Windows. In the Device Manager, the iKonvert Gateway should appear in the **Ports COM & LPT** section as a “USB Serial Port (COMx)” where x = the COM Port number allocated by Windows to the iKonvert Gateway. This is the COM port number that you will need to enter in your Navigation Software to tell it where to get the NMEA2000 data from.

For more information on the Device Manager, visit our blog at [www.digitalyacht.net](http://www.digitalyacht.net) and search for “Device Manager”. You should then be able to see an article called “Managing the Device Manager” that explains this process.

## Mac OSX

If you are using the iKonvert Gateway with a Mac, you will need to install the drivers before connecting the Gateway to a spare USB port on the Mac.

On the **Digital Yacht Software and Drivers CD**, there is a folder called “USB Drivers for AIS units” which contains a sub-folder called “Mac OSX” in here is one DMG file that you need to double click on to run. Follow the instructions that are displayed and at the end of the installation the USB drivers for the Gateway should be installed.

For more information on installing the USB drivers on a Mac please download our [Tech Note 00013-2010](#) which explains the whole procedure in more details.

## LINUX

The good news for LINUX users is that the USB drivers for the iKonvert Gateway are already included in the Kernel and it is simply a case of plugging the Gateway in to a spare USB port on the PC.

However, recently we have received reports of changes to the way Ubuntu handles COM ports which has caused some problems for our customers. Please visit our blog at [www.digitalyacht.net](http://www.digitalyacht.net) and search for “Ubuntu”. You should see an article that explains this issue and how to fix it.

# 4. Operation

## 4.1 Operating Modes

The iKonvert Gateway will support a number of different operating modes, which can be configured by changing the positions of four DIP switches inside the unit.

To open the iKonvert Gateway, just unscrew the two cross head screws in the base of the unit.

By default iKonvert is set to Mode 0, where all of the four DIP switches are OFF. In this mode it will convert all of the common GPS/Nav/Instrument data at 4800 baud.

On the following page is a table showing all of the currently supported modes. In many cases, the default mode will be fine, but if you want iKonvert to do a specific conversion i.e. Wind or Heading, or you want to convert more data at a higher baud rate, then select the required mode via the DIP switches.

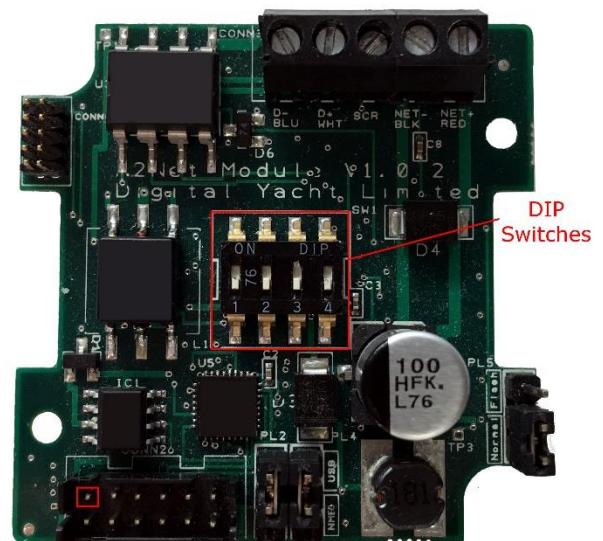



















Once you have set the DIP switches, power cycle iKonvert (OFF...wait 2 seconds...ON) and when it powers up, it will be in the selected mode.

The operating modes have been defined to satisfy the installation scenarios most commonly found on pleasure boats. If you have an installation requirement, that is not covered by one of these modes, please let us know.

Table of iKonvert Conversion Modes (V2.39 Firmware of higher)...

Switches (1234)	MODE	Interface	BAUD	NMEA DATA	Sentences
	Gateway Mode	NMEA0183	4800	GPS/Navigation/Instruments	RMC, HDG, VHW, MWV, DPT, MTW,MDA, APB, RMB, VLW, XTE, ROT, RSA
	Gateway HS Mode	NMEA0183	38400	GPS/Navigation/Instruments/AIS	RMC, HDG, VHW, MWV,DPT, MTW, MDA, APB, RMB, VLW, XTE,ROT, RSA,VDO and VDM
	GPS Mode (1Hz)	NMEA0183	4800	GPS Only (1Hz)	RMC, GSA, GSV, ZDA
	GPS HS Mode (10Hz)	NMEA0183	38400	GPS Only (10Hz)	RMC, GSA, GSV, ZDA
	Wind Mode (5Hz)	NMEA0183	4800	Wind Only (5Hz)	MWV
	AIS Mode	NMEA0183	38400	AIS + GPS Only	VDO, VDM, RMC, DPT
	Heading Mode	NMEA0183	4800	Headin Only (10Hz)	HDG
	Instrument Mode	NMEA0183	38400	GPS/Navigation/Instruments (1Hz)	RMC, HDG, VHW, MWV, DPT, MTW,MDA, APB, RMB, VLW, XTE, ROT, RSA
	Depth Mode	NMEA0183	4800	Depth+Water Temp+GPS (1Hz)	DPT, MTW,MDA, VHW, VLW, RMC
	Legacy Autopilot Mode	NMEA0183	4800	Navigation+Wind	APB, RMB, VHW, VWR
	For Future Use				
	For Future Use				
	For Future Use				
	For Future Use				
	Full Mode	NMEA0183	115200	All Supported Sentences	APB,RSA,VHW,HDG,ROT,DPT,VLW,RMC,XTE,VDR,GSV,GSA,MWV, MWD,MDA,MTW,GGA,VTG,ZDA,VWR,RMB,VDO,VDM
	RAW Mode	N2Net Protocol	230400	RAW NMEA2000 data over serial	RAW NMEA2000 data over serial

Some examples of how these Operating Modes can be used are;

- 1) You have an older DSC VHF that needs GPS data in NMEA0183 format, you can set iKonvert to **GPS (1Hz) Mode** and the VHF radio will receive this data from the NMEA2000 network.
- 2) You have an AIS unit with an NMEA0183 Output and you want to use it with a new Chart Plotter that only has an NMEA2000 interface, you can set iKonvert to **AIS Mode** and the AIS data will be converted to NMEA2000.
- 3) You have a navigation software package running on a PC/Mac and want to convert all of your NMEA2000 data in to NMEA0183, which is the only format the software supports, set iKonvert to **Gateway HS** (High Speed) mode and all of the data NMEA2000 supported by NMEA0183 sentences will be converted.

Note that conversions are in both directions, so for example in Depth Mode, if NMEA0183 Depth data is received it will be converted to NMEA2000 or if NMEA2000 Depth is on the network, then this will be converted to NMEA0183.

For software applications or devices that know how to read NMEA2000 PGNs, we have developed a special "RAW Data" Mode that takes the NMEA2000 binary PGN data and encapsulates it in a Digital Yacht proprietary NME0183 sentence.



The same application can also transmit data on to the NMEA2000 network, by sending another proprietary sentence with the binary PGN data back to iKonvert.

To set iKonvert in to this special “RAW Data” mode, simply set all of the DIP switches to “ON” and all of the NMEA2000 data will be available in the proprietary sentences at 230400 baud.

As more modes are added, Digital Yacht will release firmware updates and revisions to this manual.

## 4.2 Further Information

iKonvert is available in two versions;

- 1) USB version for use with PCs, Macs, Raspbery Pi and LINUX computers
- 2) ISO version with an opto-isolated NMEA0183 interface for use with dedicated hardware

Both versions will run the same firmware and they will support a number of different NMEA0183 conversion modes, plus the “RAW Data” mode that requires software developers to integrate/support it on their applications.

We know of a number of developers who are working on this “RAW Data” Mode integration and it is already compatible with CANBoat and the Node Signal K server.

We have created a dedicated GitHub site for iKonvert that will always have the latest Developer’s Guide, Firmware and technical information on iKonvert.

<https://github.com/digitalyacht/iKonvert>

For iKonvert technical support please email [support@digitalyacht.co.uk](mailto:support@digitalyacht.co.uk)