

iKONVERT GATEWAY (ISO)

Installation and instruction Manual



1. Introduction

Congratulations on the purchase of your iKonvert (ISO) Gateway. This product is designed to allow NMEA0183 devices to either send data to or receive data from an NMEA2000 network. With more and more equipment moving to the newer NMEA2000 interfacing standard, it is very common for boats to have a mixture of NMEA0183 and NMEA2000 equipment onboard. iKonvert allows the safe and accurate bi-directional conversion of data between the two NMEA formats.

There is no standard wiring colours or connector for NMEA0183 systems, so the NMEA0183 ISO cable of the iKonvert just has bare ended wires for connecting to other NMEA0183 equipment. Making these wiring connections requires a level of practical ability and electrical knowledge and if you are not comfortable with electrics/electronics, we recommend you have the converter installed by a professional installer/dealer.

 Before operating the unit you should also familiarise yourself again with the user manual of the NMEA2000 and NMEA0183 equipment that you will be using iKonvert with. Pay particular attention to the NMEA2000 or NMEA0183 Interfacing Menu options and any other settings that need to be configured for correct operation.

2. Before you start

You can extend the ISO cable of the iKonvert converter using any reasonable quality multi-core cable. Security Alarm cabling is usually a good choice and we would recommend using screened cable, particularly at the higher 38400 baud rate. The cable screen should only be grounded at the NMEA0183 device – not at both ends of the cable.

To install and test the iKonvert (ISO) converter you will need:

- Suitable tools and connectors to connect the iKonvert to the NMEA2000 network
- Suitable tools and connectors to connect the iKonvert to the NMEA0183 device
- M3 or M4 screws or other fixings appropriate to the mounting location
- Installation manual for the NMEA0183 device that shows wire colours and how it should be wired to other devices

3. Installation

Before starting installation select a suitable location for the iKonvert. The unit is water resistant; however it should be installed below deck in a dry location. When locating the unit you should consider:

- Routing of NMEA2000 and NMEA0183 cables to the unit
- Provision of sufficient space around the unit for comfortable cable routing.
- Maintaining the compass safe distance of 0.5m

3.1 Connecting to NMEA2000 Network

- The iKonvert, has an integral NMEA2000 cable terminated with a male connector that is designed to connect straight in to a standard NMEA2000 network via a spare "T-Piece". If you are creating a new NMEA2000 network, then you may wish to consider [Digital Yacht's NMEA2000 Starter Kit](#), that provides all of the cables, connectors and terminators required for a basic NMEA2000 network.
- iKonvert takes its power and data from the NMEA2000 network.
- If you are connecting iKonvert to a non-standard NMEA2000 network, then a suitable adaptor cable will need to be sourced from the relevant manufacturer;
 - SeaTalkNG (Raymarine P/No A06045)
 - Simnet (Simrad P/No 24006199)



3.2 Mounting

- The iKonvert Gateway has two slotted 4mm Diameter fixing holes. Use suitable fixings (not supplied) to fix the converter to a flat surface – using the dimensions and details shown in the drawing below. Note that the unit may be installed in any orientation.

Dimension drawing

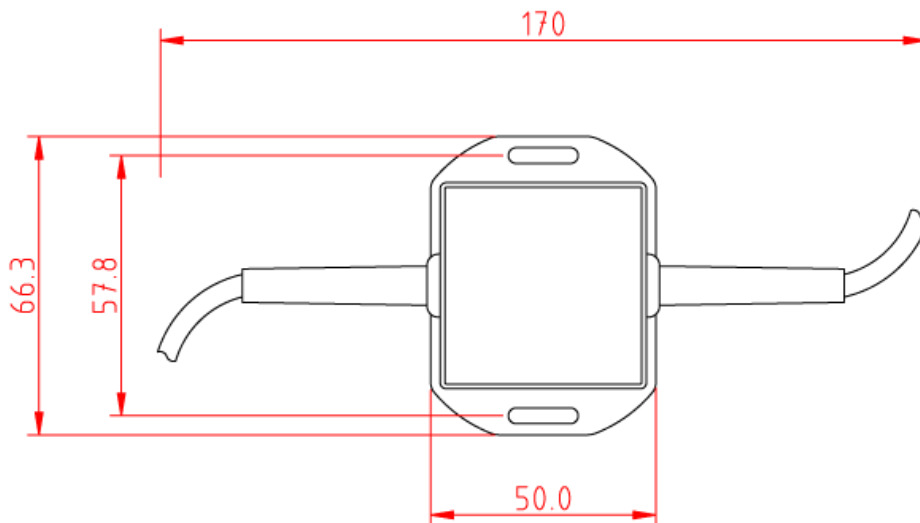

3.3 ISO Connection

The iKonvert Gateway (ISO) has an integral 1m ISO cable that can be wired to NMEA0183 devices as shown in the diagrams below. The first diagram shows the more common Differential (Two Wire) connections where the device has an Input+ and Input- or an Output+ and Output- (sometimes referred to as A and B)...

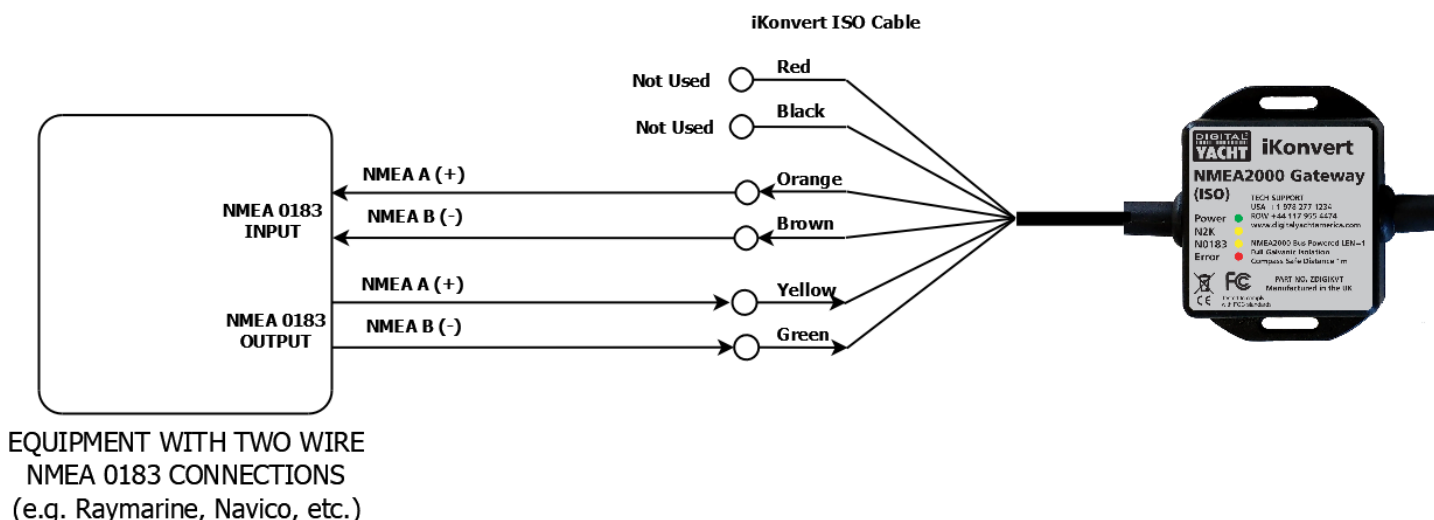



The second diagram shows the older Common Ground type connection where, to reduce the number of wires, the manufacturer just has a single Input or Output connection and it relies upon the two pieces of connected equipment having a common DC ground (Negative Battery Supply)...

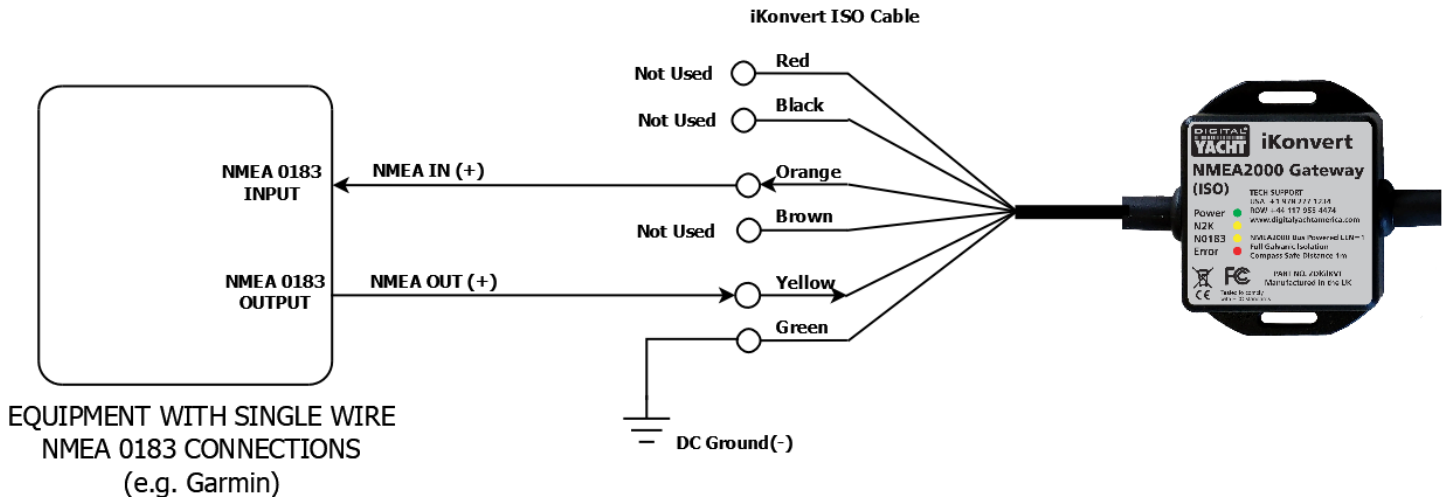

4. Operation

4.1 Operating Modes

The iKonvert Gateway will support a number of different operating modes, which can be configured by changing the positions of four DIP switches inside the unit.

To open the iKonvert Gateway, just unscrew the two cross head screws in the base of the unit.

By default iKonvert is set to Mode 0, where all of the four DIP switches are OFF. In this mode it will convert all of the common GPS/Nav/Instrument data at 4800 baud.

On the following page is a table showing all of the currently supported modes. In many cases, the default mode will be fine, but if you want iKonvert to do a specific conversion i.e. Wind or Heading, or you want to convert more data at a higher baud rate, then select the required mode via the DIP switches.

Once you have set the DIP switches, power cycle iKonvert (OFF...wait 2 seconds...ON) and when it powers up, it will be in the selected mode.

The operating modes have been defined to satisfy the installation scenarios most commonly found on pleasure boats. If you have an installation requirement, that is not covered by one of these modes, please let us know.

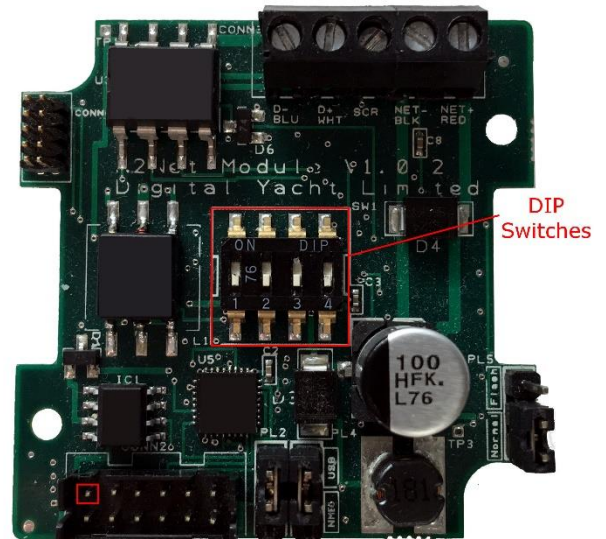



















Table of iKonvert Conversion Modes (V2.39 Firmware or higher)...

Switches (1234)	MODE	Interface	BAUD	NMEA DATA	Sentences
	Gateway Mode	NMEA0183	4800	GPS/Navigation/Instruments	RMC, HDG, VHW, MWV, DPT, MTW,MDA, APB, RMB, VLW, XTE, ROT, RSA
	Gateway HS Mode	NMEA0183	38400	GPS/Navigation/Instruments/AIS	RMC, HDG, VHW, MWV,DPT, MTW, MDA, APB, RMB, VLW, XTE,ROT, RSA,VDO and VDM
	GPS Mode (1Hz)	NMEA0183	4800	GPS Only (1Hz)	RMC, GSA, GSV, ZDA
	GPS HS Mode (10Hz)	NMEA0183	38400	GPS Only (10Hz)	RMC, GSA, GSV, ZDA
	Wind Mode (5Hz)	NMEA0183	4800	Wind Only (5Hz)	MWV
	AIS Mode	NMEA0183	38400	AIS + GPS Only	VDO, VDM, RMC, DPT
	Heading Mode	NMEA0183	4800	Headin Only (10Hz)	HDG
	Instrument Mode	NMEA0183	38400	GPS/Navigation/Instruments (1Hz)	RMC, HDG, VHW, MWV, DPT, MTW,MDA, APB, RMB, VLW, XTE, ROT, RSA
	Depth Mode	NMEA0183	4800	Depth+Water Temp+GPS (1Hz)	DPT, MTW,MDA, VHW, VLW, RMC
	Legacy Autopilot Mode	NMEA0183	4800	Navigation+Wind	APB, RMB, VHW, VWR
	For Future Use				
	For Future Use				
	For Future Use				
	For Future Use				
	Full Mode	NMEA0183	115200	All Supported Sentences	APB,RSA,VHW,HDG,ROT,DPT,VLW,RMC,XTE,VDR,GSV,GSA,MWV, MWD,MDA,MTW,GGA,VTG,ZDA,VWR,RMB,VDO,VDM
	RAW Mode	N2Net Protocol	230400	RAW NMEA2000 data over serial	RAW NMEA2000 data over serial

Some examples of how these Operating Modes can be used are;

- 1) You have an older DSC VHF that needs GPS data in NMEA0183 format, you can set iKonvert to **GPS (1Hz) Mode** and the VHF radio will receive this data from the NMEA2000 network.
- 2) You have an AIS unit with an NMEA0183 Output and you want to use it with a new Chart Plotter that only has an NMEA2000 interface, you can set iKonvert to **AIS Mode** and the AIS data will be converted to NMEA2000.
- 3) You have a navigation software package running on a PC/Mac and want to convert all of your NMEA2000 data in to NMEA0183, which is the only format the software supports, set iKonvert to **Gateway HS** (High Speed) mode and all of the data NMEA2000 supported by NMEA0183 sentences will be converted.

Note that conversions are in both directions, so for example in Depth Mode, if NMEA0183 Depth data is received it will be converted to NMEA2000 or if NMEA2000 Depth is on the network, then this will be converted to NMEA0183.

For software applications or devices that know how to read NMEA2000 PGNs, we have developed a special “RAW Data” Mode that takes the NMEA2000 binary PGN data and encapsulates it in a Digital Yacht proprietary NME0183 sentence. The same application can also transmit data on to the NMEA2000 network, by sending another proprietary sentence with the binary PGN data back to iKonvert.

To set iKonvert in to this special “RAW Data” mode, simply set all of the DIP switches to “ON” and all of the NMEA2000 data will be available in the proprietary sentences at 230400 baud.

As more modes are added, Digital Yacht will release firmware updates and revisions to this manual.



4.2 Further Information

iKonvert is available in two versions;

- 1) USB version for use with PCs, Macs, Raspberry Pi and LINUX computers
- 2) ISO version with an opto-isolated NMEA0183 interface for use with dedicated hardware

Both versions will run the same firmware and they will support a number of different NMEA0183 conversion modes, plus the “RAW Data” mode that requires software developers to integrate/support it on their applications.

We know of a number of developers who are working on this “RAW Data” Mode integration and it is already compatible with CANBoat and the Node Signal K server.

We have created a dedicated GitHub site for iKonvert that will always have the latest Developer’s Guide, Firmware and technical information on iKonvert.

<https://github.com/digitalyacht/iKonvert>

For iKonvert technical support please email support@digitalyacht.co.uk